

Female Header 2.54 mm

180° Series

SPECIFICATIONS

Current Rating: 3 A
 Insulator Resistance: 5000 MOhm min.
 Contact Resistance: 20 mOhm max.
 Dielectric Withstanding: AC 1000 V
 Operating Temperature: -40°C ~ +105°C
 Soldering Temperature: 260°C for 3~5 sec. max
 Contact Material: Brass
 Insulator Material: Polyester, UL 94V-0
 Standard: Nylon-6T
 Finish: Tin, Gold or Duplex Plated
 Standard: Gold Flash all over
 Note: Duplex Plating: Gold Plated on contact area, Tin on solder area

F105-SGN-D025-XX

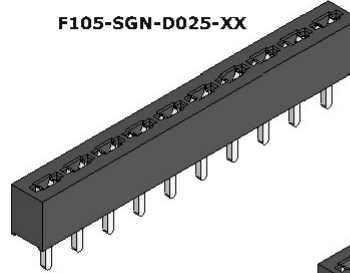

F205-SGN-D025-XX

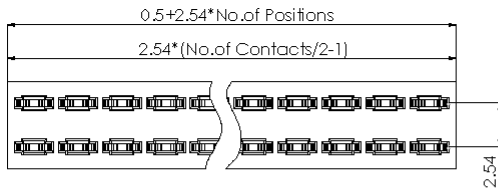
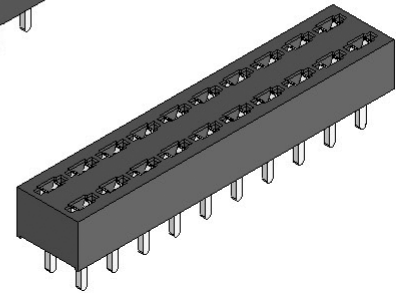

[F105]

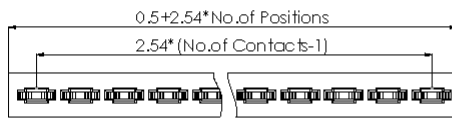
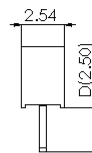

[F205]

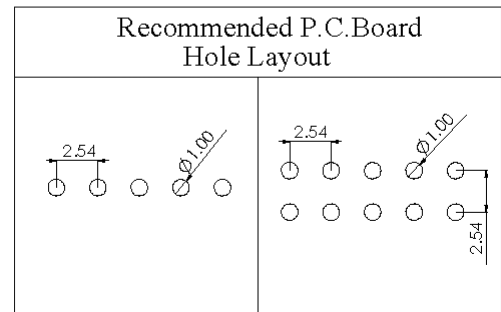
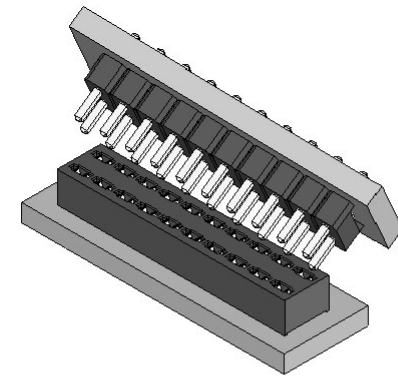
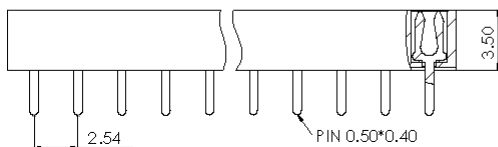
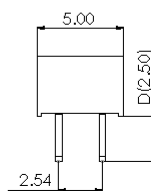

How to order

Unit: mm

Series	Connector Type	Contact Plating	Material	Pin Length mm	Number of Contacts
FXXX	- X	X	X	- DXXX	- XX
F105:F/H 2.54 H:3.50 Single Row F205:F/H 2.54 H:3.50 Dual Row	S: Straight Type	G: Gold Flash T: Tin Plated A: 10U"Gold B: 15U"Gold C: 20U"Gold ⊙ Duplex Plating D: Gold Flash/Tin (Standard: G)	P: PBT N: Nylon-6T (Standard: N)	S-D D025	F105: (02 TO 28 Contacts) F205: (04 TO 50 Contacts)